

# Q Series

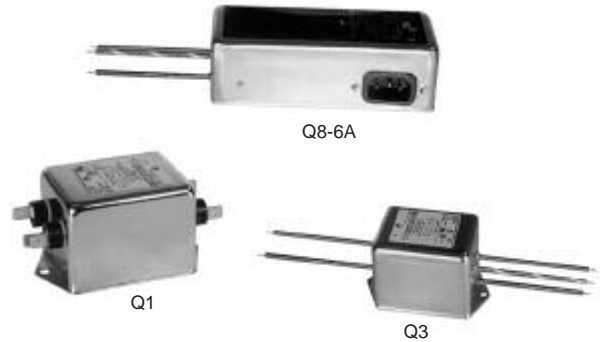

UL Recognized  
CSA Certified  
VDE Approved



## Q Series

This series of RFI power line filters has been developed specifically for switching power supplies and is designed to be all the power line filtering needed to control conducted emissions *all the way down to 10kHz*. High attenuation is provided for both common mode and differential mode interference throughout the frequency range with no degradation of performance due to the large peak currents drawn by switching power supplies.

These filters are an ideal choice for applications that must meet emission limits below 150kHz, as well as the mandated limits above 150kHz. In most cases they will bring such equipment into compliance with the B-level limits of CISPR 22. They are also well suited for bringing ISM equipment (such as ultrasonic cleaners) into compliance with the limits of FCC Part 18, from 10kHz to 30MHz.

The EQ models meet the very low leakage current requirements VDE portable equipment, and (120 Volt) UL544 non-patient medical equipment. The VQ models offer higher common mode performance at the expense of higher leakage current, but still meet the leakage current limits of UL, CSA, and VDE non-portable equipment.

## Electrical Schematics

### 3EQ & 3VQ Models

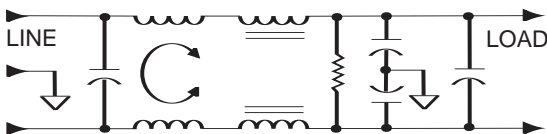

### 6EQ & 20EQ Models

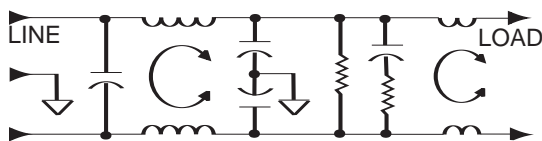

Resistor location for reference only.

## Specifications

### Maximum leakage current, each line-to-ground

	VQ Models	EQ Models
@ 120 VAC 60 Hz (3A, 20A):	.73 mA	.22 mA
@ 120 VAC 60 Hz (6A):	—	.29 mA
@ 250 VAC 50 Hz (3A, 20A):	1.27 mA	.38 mA
@ 250 VAC 50 Hz (6A):	—	.51 mA

### Hipot rating (one minute):

line-to-ground	2250 VDC
line-to-line	1450 VDC

### Operating frequency:

50/60 Hz

### Rated voltage (max.):

250 VAC

### Rated current:

3VQ/3EQ	3A
6EQ	6A
20EQ1/20VQ1	20A

### Minimum insertion loss in dB:

Line-to-ground in 50 ohm circuit

Current Rating	Frequency—MHz								
	.01	.02	.05	.15	.5	1	5	10	30
3VQ	22	27	37	50	55	55	55	50	55
3EQ	22	27	36	47	47	43	45	45	45
6EQ	26	31	20	68	72	72	65	65	65
20EQ1	6	10	8	39	60	65	65	65	55
20VQ1	6	3	17	52	65	70	70	70	70

Line-to-line in 50 ohm circuit

Current Rating	Frequency—MHz								
	.01	.02	.05	.15	.5	1	5	10	30
3VQ	1	17	42	65	75	75	60	65	65
3EQ	1	17	42	65	75	75	65	65	60
6EQ	6	10	43	70	75	75	65	55	55
20EQ1	15	20	20	46	65	70	65	60	60
20VQ1	15	20	20	46	65	70	65	60	60

## Line Cord

Line Cord No. GA400: 7 1/2 foot, 3-conductor line cord to mate with Q8 models.

# Q Series

## Case Styles

### Q1

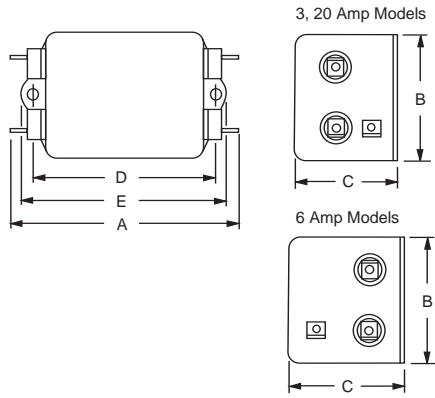

Typical dimensions:  
Terminals: .250 [6.35] (5) Holes: .07 [1.8] Dia. (4)  
Mounting Holes: .188 [4.78] Dia. (2) Slot: .07 x .16 [1.8 x 4.1]

### Q3

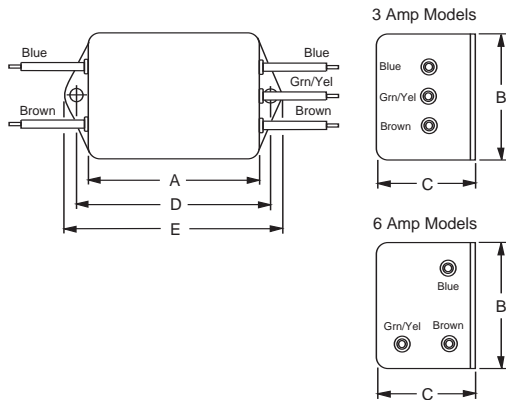

Typical dimensions:  
Wire leads: 4.0 [101.6] Min. Mounting Holes: .188 [4.78] Dia. (2)

### 3 Amp EQ/VQ8 & EQ/VQ8M (with metric insert)

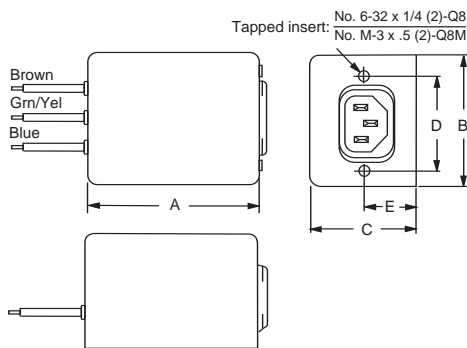

Typical dimensions:  
Wire leads: 6.0 [152.4] Min.

### 6 Amp EQ/VQ8 & EQ/VQ8M (with metric insert)

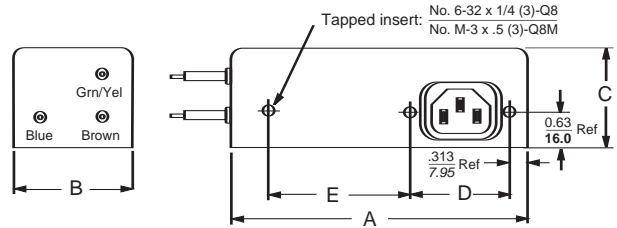

Typical dimensions:  
Wire leads: 6.0 [152.4] Min.

### Recommended Panel Cutout

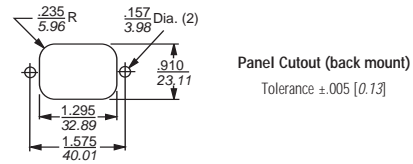

### Case Dimensions

Part No.	A (max)	B (max)	C (max)	D ±.015 ±.38	E (max)
3VQ1, 3EQ1	<b>3.85</b> 97.8	<b>2.07</b> 52.6	<b>1.78</b> 45.2	<b>2.938</b> 74.63	<b>3.34</b> 84.8
3VQ3, 3EQ3	<b>2.56</b> 65.0	<b>2.07</b> 52.6	<b>1.78</b> 45.2	<b>2.938</b> 74.63	<b>3.34</b> 84.8
3VQ8, 3VQ8M	<b>3.07</b> 78.0	<b>2.25</b> 57.2	<b>1.78</b> 45.2	<b>1.575</b> 40.01	<b>0.63</b> 16.0 †
3EQ8, 3EQ8M	<b>4.98</b> 126.5	<b>2.27</b> 57.7	<b>1.80</b> 45.7	<b>4.063</b> 103.2	<b>4.47</b> 113.5
6EQ1	<b>3.69</b> 93.7	<b>2.27</b> 57.7	<b>1.80</b> 45.7	<b>4.063</b> 103.2	<b>4.47</b> 113.5
6EQ3	<b>5.47</b> 138.9	<b>2.07</b> 52.6	<b>1.78</b> 45.2	<b>1.575</b> 40.01	<b>2.70</b> 68.0
6EQ8, 6EQ8M	<b>6.66</b> 168.1	<b>2.07</b> 52.6	<b>2.28</b> 57.9	<b>5.625</b> 142.9	<b>6.03</b> 153.2 †

† ±.02 [±.5]

### Part Numbers

3EQ1	3VQ1
3EQ3	3VQ3
3EQ8	3VQ8
3EQ8M	3VQ8M
6EQ1	20VQ1
6EQ3	
6EQ8	
6EQ8M	
20EQ1	
Line Cord:	GA400